

第59回技能五輪全国大会「建築大工」職種競技課題図

※○印は基準点を示す
※単位はmm

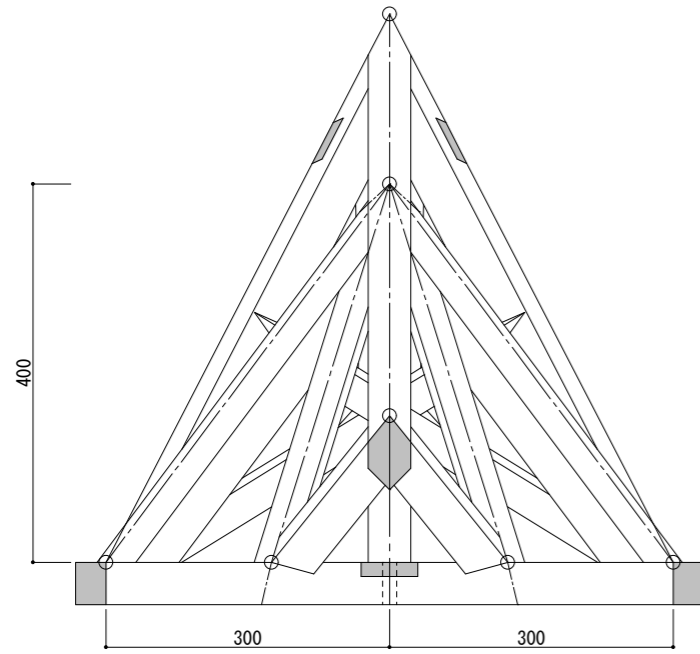

正面図

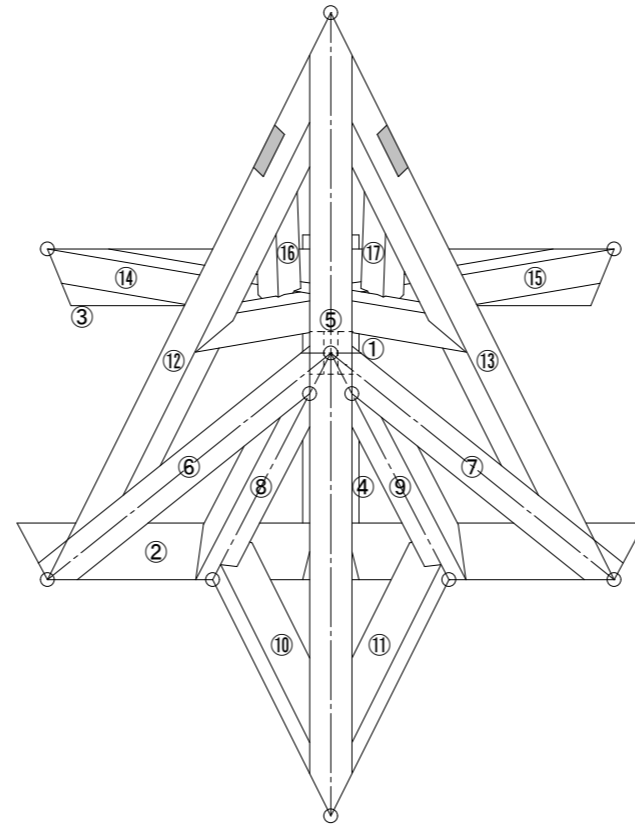

平面図

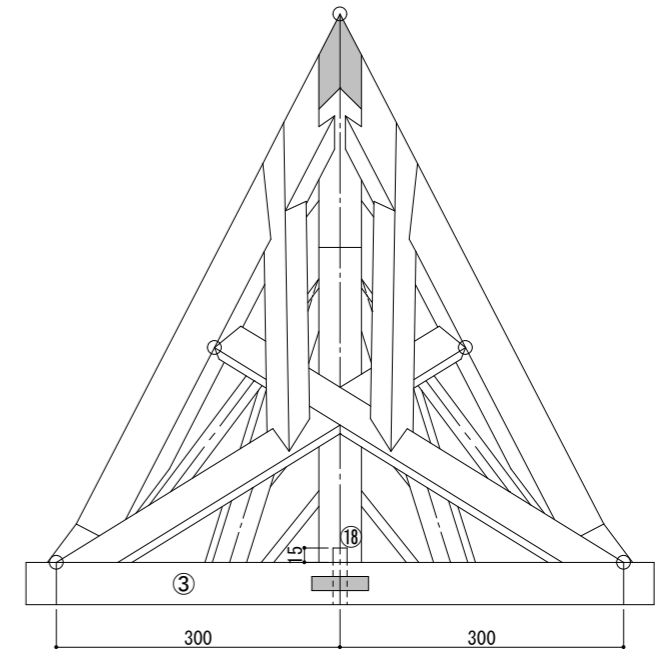

背面図

⑤棟木背面先端

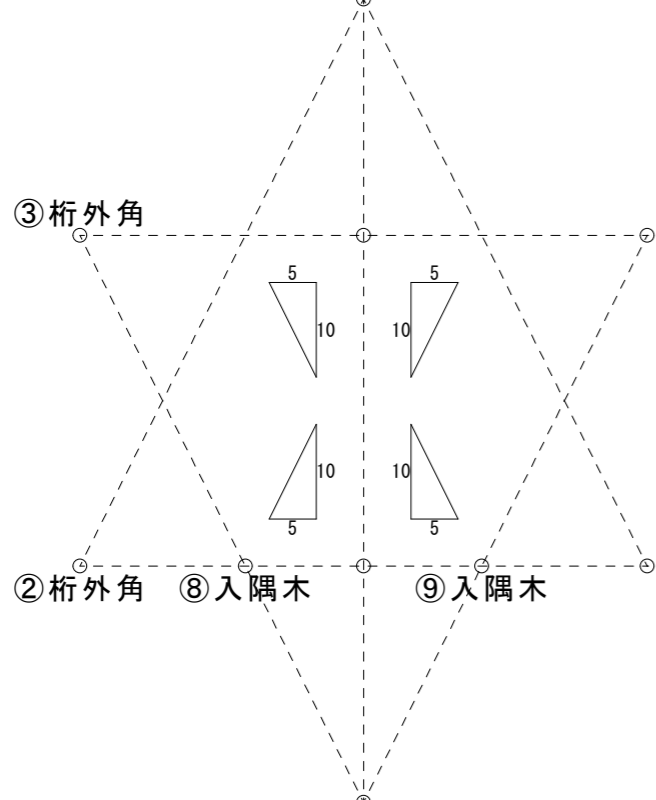

⑤棟木正面先端

平面図基準図

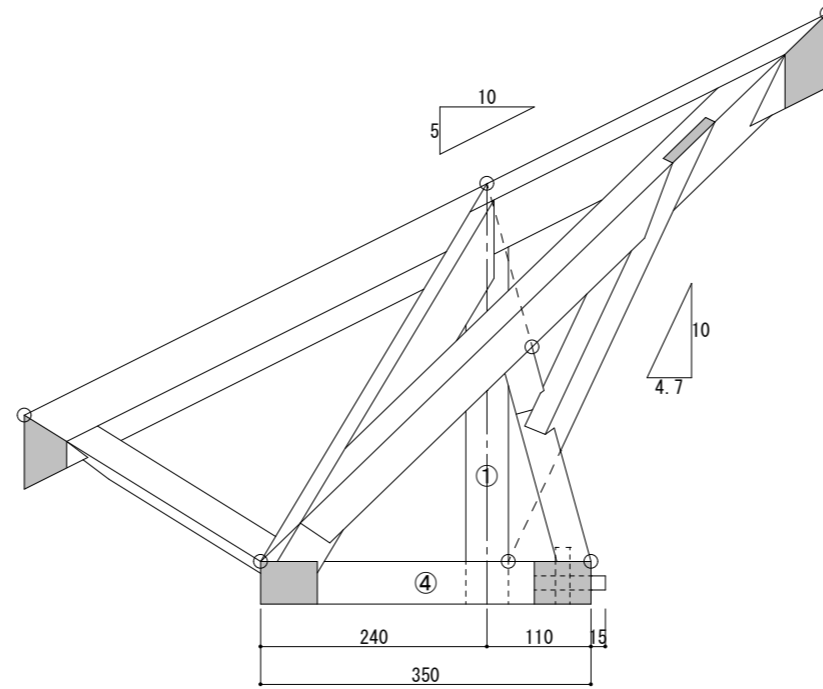

側面図

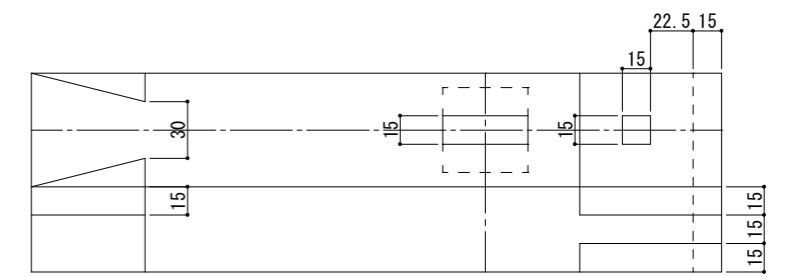

④梁詳細図

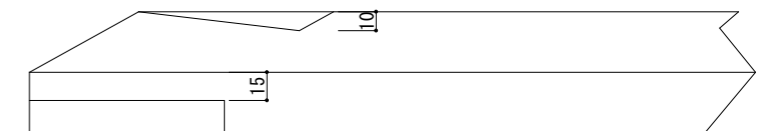

方杖詳細図